

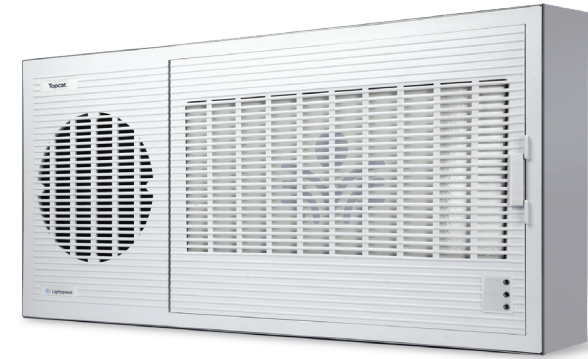

Topcat™

Instructional Audio System



User Manual





Table of Contents

OVERVIEW

- 3** Important Safety Instructions
- 5** System Components and Unpacking
- 6** Optional Components
- 7** Topcat Side Panel Connections
- 8** Topcat Controls (Inside Speaker Door)
- 9** Flexmike Controls and Connections
- 10** Microphone Cradle Charger
- 11** Media Connector Controls and Indicators

SET-UP

- 13** Turn Power On
- 14** Set Up and Charging the Flexmike
- 15** Pairing Microphones to Topcat
- 16** Pairing Topcat to Media Connector
- 17** Optional Media Connector: Initial Set Up
- 18** Media Connector: Audio Integration

DAILY OPERATION

- 19** Operating the Flexmike
- 20** Using Your Microphone as a Wireless Audio Link
- 21** Using the Media Connector

OPTIONAL ACCESSORIES

- 22** Sharemike Controls and Connections
- 23** Sharemike: Charging
- 24** Sharemike: Initial Set-Up
- 25** Optional PageFirst Kit
- 26** Activate System with Pods

MAINTENANCE & TROUBLESHOOTING

- 27** Flexmike Battery Replacement
- 28** Sharemike Battery Replacement
- 29** Troubleshooting

WARRANTY, SAFETY & SPECIFICATIONS

- 30** Five-Year Limited Warranty
- 31** Safety Warnings and Certifications
- 37** System Components
- 38** System Specifications



OVERVIEW

Important Safety Instructions

1. Do not use the apparatus near water.
2. Clean only with dry cloth.
3. Do not block any ventilation openings.
4. Do not install near any heat sources such as radiators, heat registers, stoves, or other apparatus (including amplifiers) that produce heat.
5. Do not defeat the safety purpose of the polarized or grounding-type plug. A polarized plug has two blades with one wider than the other. A grounding-type plug has two blades and a third grounding prong. The wide blade or the third prong is provided for your safety. If the provided plug does not fit into your outlet, consult an electrician for replacement of the outlet.
6. Protect the power cord from being walked on or pinched particularly at plugs, convenience receptacles, and the point where they exit from the apparatus.
7. Unplug this apparatus during lightning storms or when unused for long periods of time.
8. Refer all servicing to qualified service personnel. Servicing is required when the apparatus has been damaged in any way, such as power-supply cord or plug is damaged, liquid has been spilled or objects have fallen into the apparatus, the apparatus has been exposed to rain or moisture, does not operate normally, or has been dropped.
9. When the mains plug or appliance coupler is used as the disconnect device, it shall remain readily operable.
10. Please keep the unit in a good ventilation environment.
11. WARNING: To reduce the risk of fire or electric shock, do not expose this apparatus to rain or moisture.
12. Apparatus shall not be exposed to dripping or splashing and no objects filled with liquids, such as vases, shall be placed on the apparatus.
13. WARNING: Battery pack shall not be exposed to excessive heat such as sunshine, fire or the like. (1) The battery pack is not serviceable. Do not open, disassemble, or service any battery pack. (2) Do not crush or cut or puncture the internal battery cell. (3) Do not short-circuit the battery, or expose it to water or other liquids. (4) Do not touch the internal battery cell for any reason. (5) Keep the battery away from fire or a hot oven. Do not dispose of the battery into fire or a hot oven. (6) Keep the product with battery away from extremely low air pressure or high temperature surrounding environment. Battery subjected to extremely low air pressure may result in an explosion or the leakage of flammable liquid or gas. (7) Stop using the battery pack if it is damaged, or if you notice any discharge or the buildup of foreign materials on the battery contacts. (8) Do not put the battery in trash that is disposed of in landfills. When disposing of the battery pack, comply with local ordinances or regulations.
14. CAUTION: Risk of explosion if battery is replaced by any battery other than Lightspeed Part # L3.7V



Important Safety Instructions (cont.)

To avoid potential equipment damage and/or serious injury, READ AND FOLLOW all safety precautions when installing Topcat. WARNINGS are included throughout the procedural steps in this guide, and are repeated below for emphasis.

- **USE A LICENSED ELECTRICIAN FOR POWER CONNECTIONS.** Topcat system uses standard 100 – 240VAC power. Obtain the services of a licensed electrician when supplying and connecting power to the ceiling enclosure. BE SURE electrical installation complies with local building codes. Improperly installing and/or connecting power to the system may result in EQUIPMENT DAMAGE, serious INJURY and/or DEATH.
- **DO NOT INSTALL ALONE.** The ceiling enclosure weighs approximately 20 lbs (9 kg), and requires at least two people to install. DO NOT install alone.
- **USE SUITABLE LADDERS.** Use proper ladders or support platforms when installing Topcat enclosure. DO NOT stand on chairs, tables, or other unsuitable surfaces.
- **SUPPORT THE CEILING ENCLOSURE PROPERLY. DO NOT** allow the full weight of the ceiling enclosure to rest on the tile grid of the ceiling. The ceiling enclosure is designed to be suspended at TWO POINTS by suspension wires (secured to rafters or other suitable building structure) and to rest LIGHTLY on the tile grid.



The lightning flash with arrowhead symbol within an equilateral triangle is intended to alert the user to the presence of uninsulated “dangerous voltage” within the product’s enclosure, that may be sufficient magnitude to constitute a risk of electric shock.



The exclamation point within an equilateral triangle is intended to alert the user to the presence of important operating and maintenance (servicing) instructions in the literature accompanying the appliance.



OVERVIEW

System Components and Unpacking

The standard configuration of the Topcat system includes:

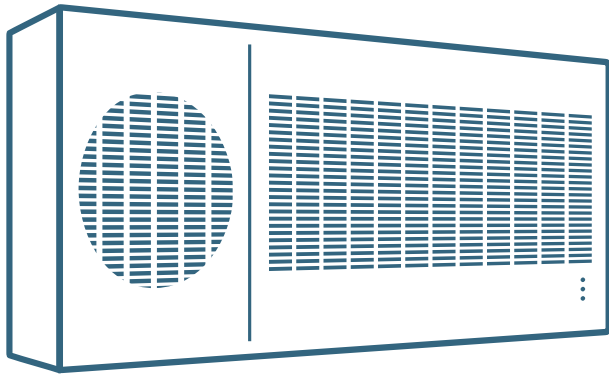

Topcat

Instructional Audio System
and Power Supply



Flexmike

Teacher Microphone

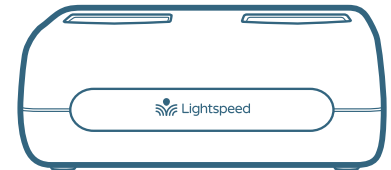

Microphone Cradle Charger

and Power Supply



NOTE ON PAIRING: Topcat and any wireless components (microphones, Activate Station, Media Connector) are pre-paired at the Lightspeed factory as required for proper operation. If paired components are separated and swapped during the installation process, they must be re-paired.



Optional Components

Optional equipment which may be part of your Topcat system



Media Connector

and Power Adapter



ShareMike

Student Microphone

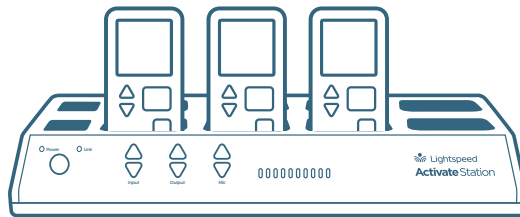

Activate System

Group Learning Pods

*For further information on Activate,
please visit www.lightspeed-tek.com*

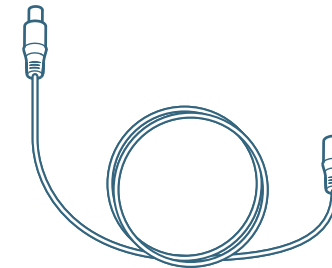

DC Extension Cable



Topcat Side Panel Connections

1. **AUX POWER INPUT CONNECTOR** (optional): For use during installations where AC power is not available in the ceiling. Accepts 24VDC, 2.5A connector from an external power supply.
2. **CONTACT CLOSURE:** Internal relay contact closure to provide signal to notify external system based on user input.
3. **RELAY INPUT:** Senses external relay closure to mute Topcat audio when a signal from a fire alarm, IP paging system or other device is detected.
4. **PAGEFIRST INPUT:** Connect the input from optional PageFirst sensor when interfacing with the building's paging system. Use the PageFirst Level control inside the speaker cavity to adjust the sensitivity if needed.
5. **TOPCAT AUDIO LINK:** Digital Audio Input and Audio Output to connect one Topcat to another.
6. **AUDIO INPUT:** This connection accepts an audio signal from other technology so all multimedia can be distributed evenly throughout the classroom.
7. **PROGRAMMING CONNECTION:** For factory use only.

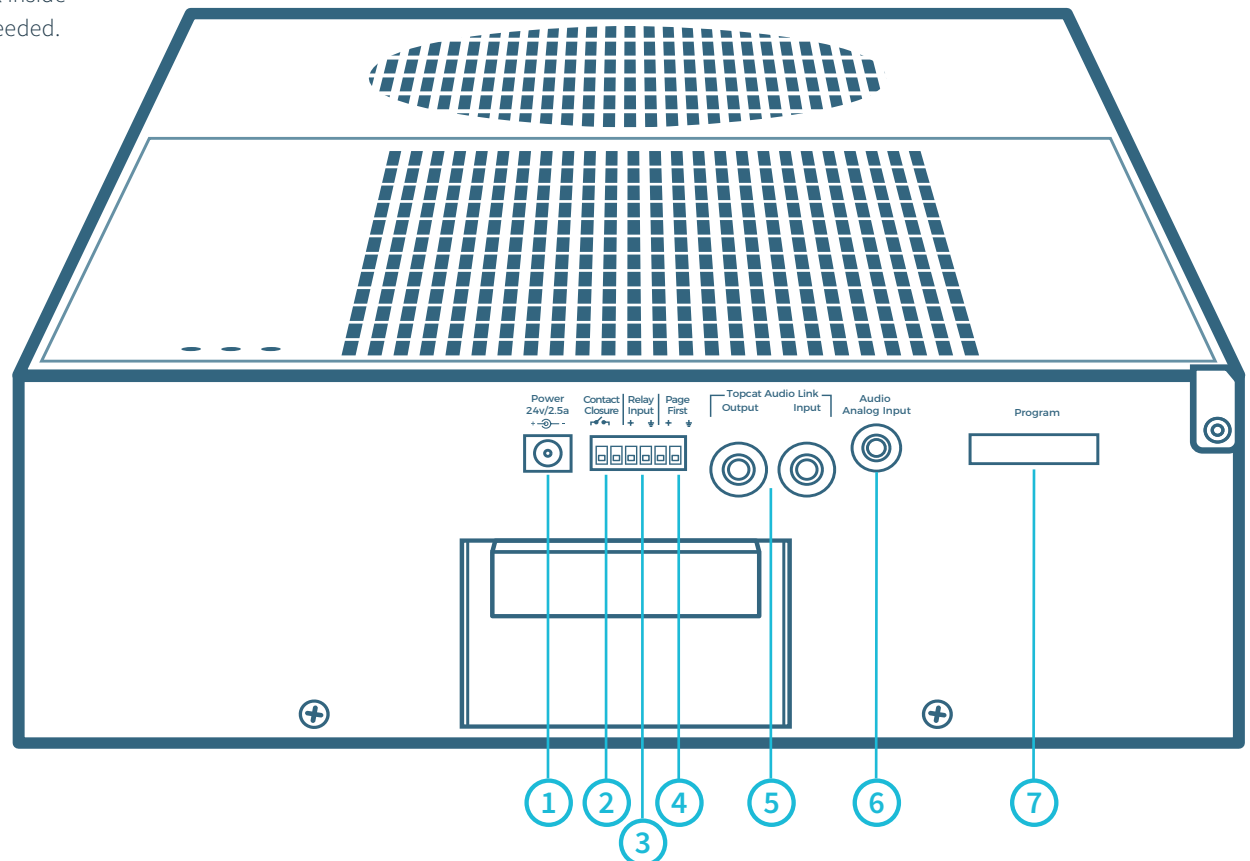



Topcat Controls (Inside Speaker Door)

1. **TONE AND AUDIO IN SELECTOR BUTTONS:** Select tone or audio input volume for adjustment
2. **LEVEL ADJUSTMENT:** Adjusts level for tone or audio input volume depending on the mode selected.
3. **PAGEFIRST LEVEL:** Use the Page Level Control to adjust the sensitivity of PageFirst if needed.

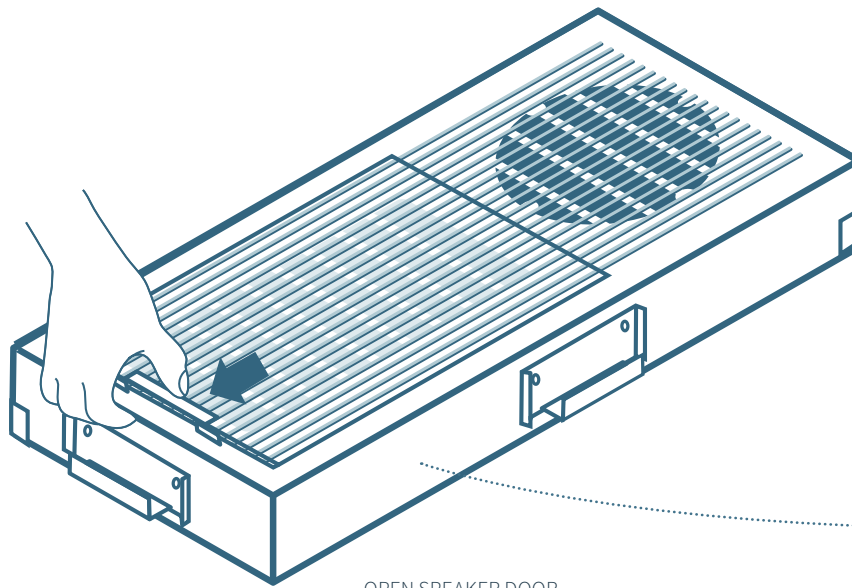

OPEN SPEAKER DOOR

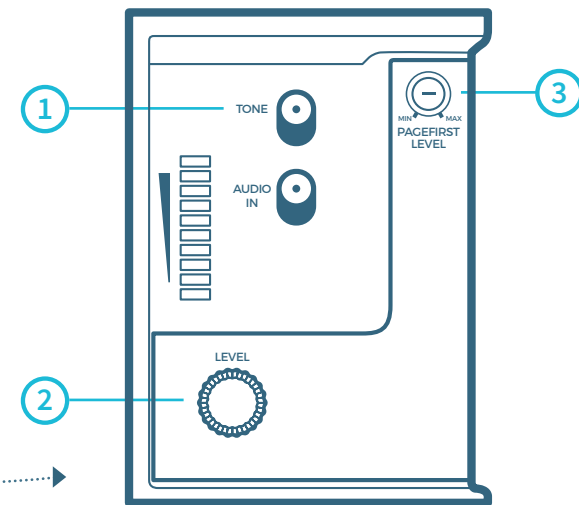

INSIDE CONTROLS



Flexmike Controls and Connections

1. **POWER/MUTE SWITCH:** Press and hold to power on, press to mute, press and hold to power off.

Blue light: Talk

White light: Mute

2. **IR TRANSMITTER:** For pairing to base unit.

3. **MIC 1 STATUS:** lighted to indicate microphone is registered as Mic 1

White: solid = Normal operation

White: flashing = Linking in progress

4. **MIC 2 STATUS:** When using a second microphone, this LED is lighted to indicate microphone is registered as Mic 2

White: solid = Normal operation

White: flashing = Linking in progress

5. **MICROPHONE VOLUME UP/DOWN**

6. **POWER STATUS LIGHT**

Red light: In operation, turns red to indicate low battery.

White light: Normal operation

When charging in Cradle Charger:

Red light: Charging

Green light: Charging complete

7. **EARBUD/MIC CONNECTION:** Connect the earbud for monitoring for use with Pods only, also for use with optional EMA (earset) and LMA (lapel) microphones.

8. **LANYARD INTERFACE:** Insert the lanyard into this hook to wear the Flexmike.

9. **BATTERY:** Remove the battery to replace the rechargeable battery pack.

10. **USB INPUT:** Connect audio source to send to Topcat. USB input can also be used for charging.

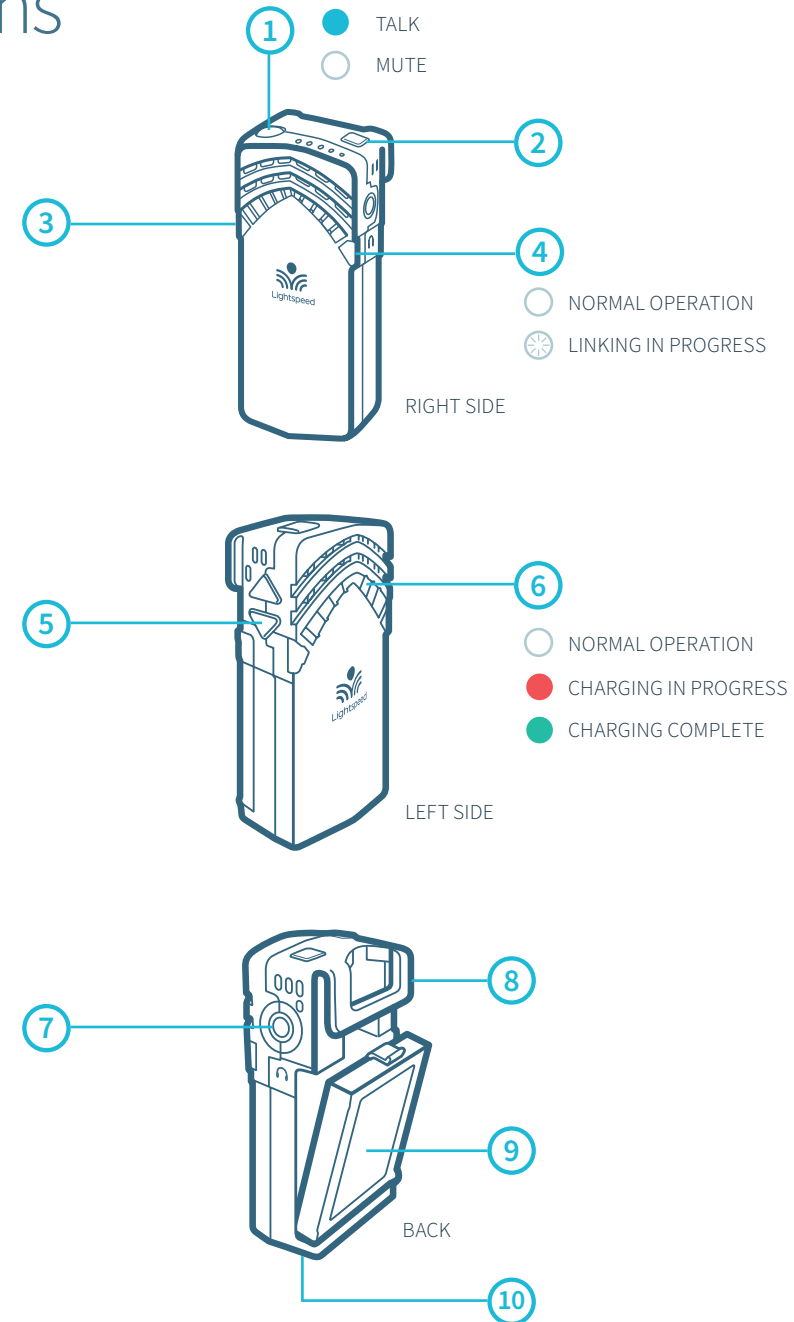



Microphone Cradle Charger

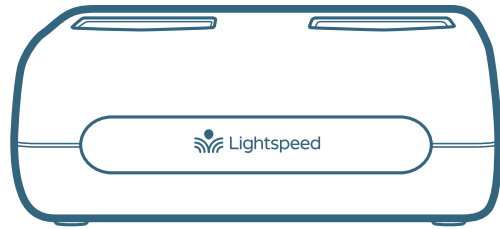

DC POWER PORT: Connect the 5V/1.0A DC power cord

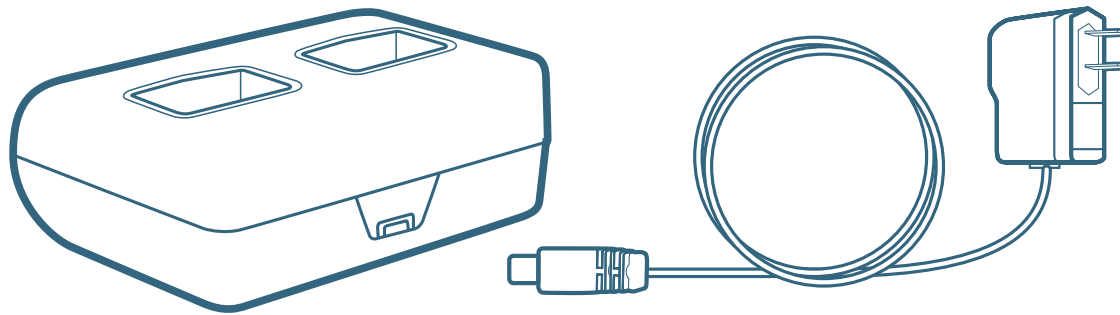



Media Connector Controls and Indicators

FRONT PANEL

1. **POWER LIGHT**
White light: Power on
2. **POWER BUTTON / VOLUME ADJUSTMENT:** Press this button to turn the system power on or off. This also functions as an adjustment knob for the volume and tone depending on the mode selected (see 4, 5, 6 below).
3. **STATUS LIGHT:** Media Connector link and pair indicators.
Solid white: Media Connector is paired to the system
Off: Media Connector is not paired to the system
4. **AUDIO INPUT VOLUME SELECTOR:** Selects Volume as the mode for the adjustment knob (2) for the audio sources connected to the audio inputs on the back of the Media Connector.
5. **AUDIO OUTPUT VOLUME SELECTOR:** Selects Volume as the mode for the adjustment knob (2) for the audio devices connected to the audio outputs on the back of the Media Connector.
6. **tone SELECTOR:** Selects Tone as the mode for the adjustment knob (2) for the microphone. This adjusts the bass or treble that is heard through the classroom speaker.

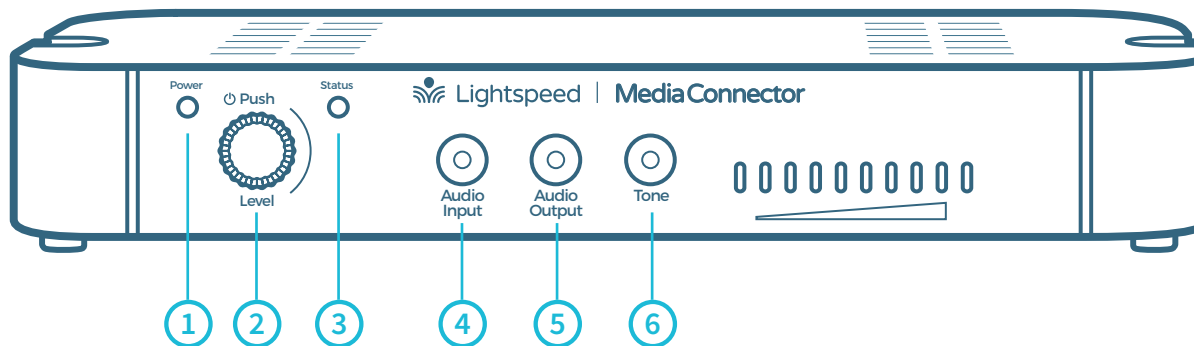



Media Connector Controls and Indicators (Optional)

BACK PANEL

1. **AUDIO INPUTS:** 3.5mm stereo connectors for connecting classroom audio sources to be played through audio system.
2. **AUDIO OUTPUTS:** 3.5mm stereo connectors for connecting to an assisted listening device (ALD) or to a computer for recording.
3. **USB INPUT:** Plug the USB-C end of the power cable into this USB port on the Media Connector.
 - The USB port supplies power to Media Connector when connected to the Media Connector power supply, or from a laptop.
 - It also acts as an input for a digital audio when connected to an audio source. Note that when the USB is used for audio input, the other four audio input jacks are not operational.

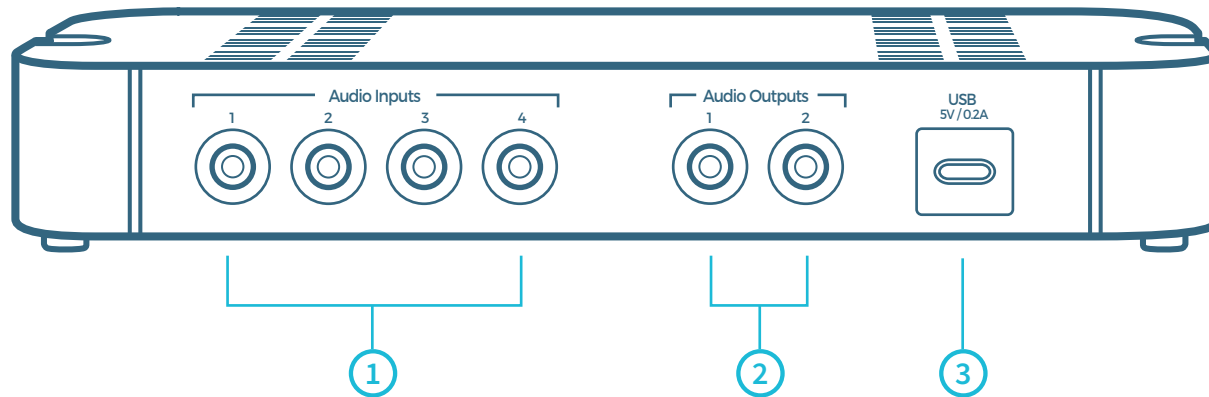



SET-UP & OPERATION

Turn Power On

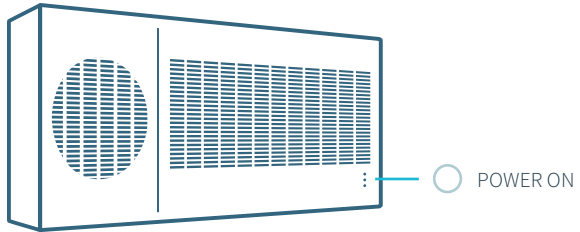

When powered on, the white LED on Topcat speaker panel will glow. Please refer to Installation Guide for instructions.





Setting Up the Flexmike

Once the Flexmike is charged, follow these steps for use.

1. Remove the Flexmike from the charger and put it on by connecting the magnetic clasps behind your neck. Adjust the lanyard so that the top of the Flexmike aligns with the collarbone.
2. The Flexmike will automatically power on and mute when it is removed from the charger.
3. The microphone volume on the Flexmike is set at the factory to the midpoint. It is adjusted by the up/ down buttons on the side of the mic.
4. While speaking in a normal voice, fine tune the microphone volume. Proper volume level should be as follows:
 - Your voice should be clearly heard by another person on the other side of the room.
 - You should barely be able to hear your own voice.
 - There should not be any audio “feedback” or squealing outside of 2-3 feet (if there is, turn the volume down slightly).

REMEMBER: This equipment supplements the user’s voice so they are able to speak in a conversational tone. Having the volume set too high will result in feedback and listener fatigue.

- Once initial volume level is set, walk around the room and listen for overall audio quality.
- If further fine tuning is required, you may need to adjust the Tone Control inside the speaker case.
- If the Flexmike is out of range, it will automatically shut off after 30 minutes of trying to reconnect. Once you are back in the classroom, or in range, simply press and hold the power button on the Flexmike to power it up and resume normal operation.

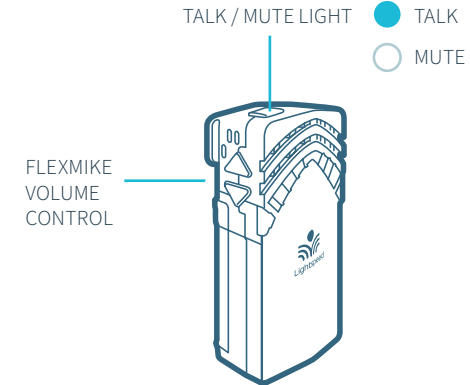
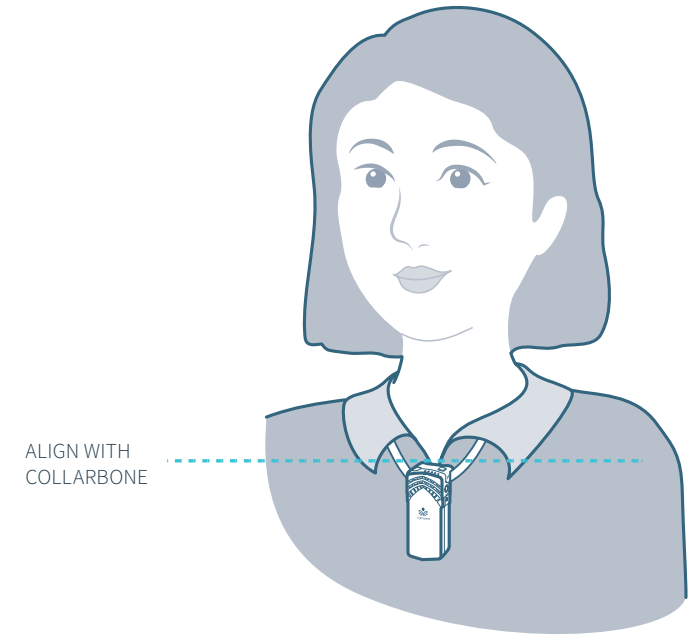



Charging the Flexmike

BEFORE USE, THE FLEXMIKE SHOULD BE CHARGED

It will take 5-6 hours for the Flexmike to obtain a full charge. A fully charged Flexmike will last for up to 8 hours of use. If microphones are used daily, they should be charged each night.

Replacement lithium polymer battery packs may only be purchased through LightSpeed Technologies (part #L3.7V).

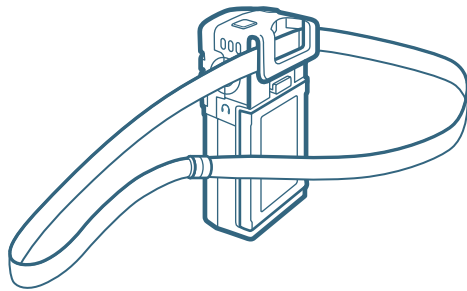

ATTACH LANYARD

Hang the Flexmike on the lanyard opposite the magnetic clasp.

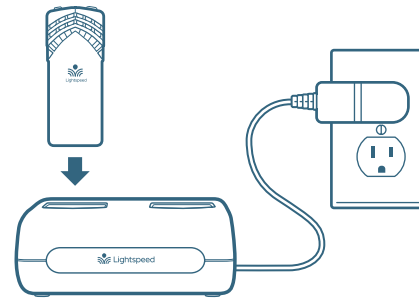

CONNECT CRADLE CHARGER

Plug power cord into the cradle charger and then plug the AC end into an electrical outlet.

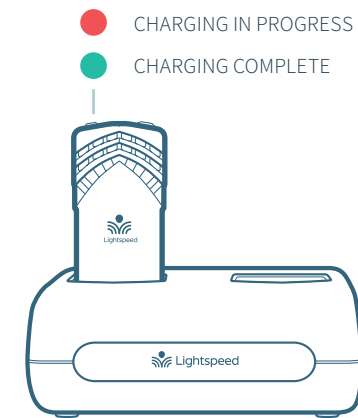

CHARGE FLEXMIKE

Place the Flexmike into the cradle.

The LED on the Flexmike power light will glow red indicating charging has started.

It takes 5-6 hours to fully charge the Flexmike battery. When charging is complete, the power status light will glow green.



Daily Use of the Flexmike

1. AT THE START OF THE DAY, REMOVE FLEXMIKE FROM THE CHARGER

- The microphone will default to the Mute position, the status light will turn to white.
- Place the microphone around your neck.
- Press and release the power/mute button. The light will turn blue, indicating the microphone is active and ready to use.
- Adjust volume with the UP/DOWN buttons if necessary.
- If Flexmike needs to be powered down for some time, press and hold the power button. To power Flexmike again, press and hold the power button until the power status light turns white.

2. PRIVATE CONVERSATIONS

- Mute the Flexmike during private conversations by momentarily pressing the power button. When muted, the blue light turns white.
- When conversation is over, momentarily press the power button again to unmute the Flexmike.

3. END OF DAY

- Place the Flexmike into the cradle charger and ensure that it is plugged into an outlet.
- The Flexmike will stay powered on during charging, but will automatically be muted.
- It is not necessary to turn off the Topcat at end of day, but you may do so by pressing the power button on the front panel of the Activate or the Media Connector.
- If you do want to power it down, when the Flexmike is removed from charging the next day, it will automatically power the Topcat on.

POWER / MUTE BUTTON
& STATUS LIGHT



VOLUME CONTROL

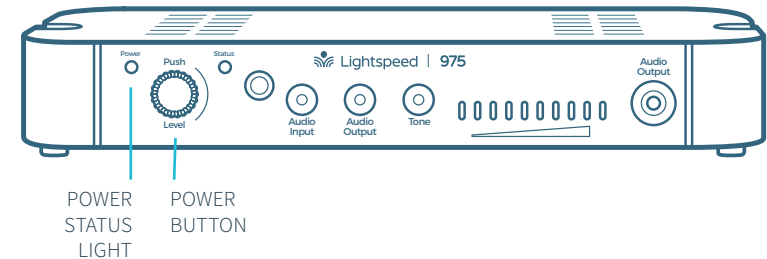
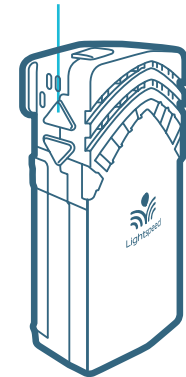



Pairing Microphones to Topcat



Your system is shipped with microphones and base units pre-paired for quick and easy use.

If for any reason you need to pair new components, follow this pairing process:

PLEASE NOTE: Microphones should be out of the charger while pairing.

1

From a powered off state, point the IR transmitter lens toward the base unit (for ShareMike, the transmitter lens is located on the back of the microphone).

2

Press and hold the power button for 5 seconds until the mic 1 and mic 2 lights start flashing, then release the button and let the pairing process finish.

3

The "status" light on the base unit will light up indicating the pairing process is complete. The mic 1 or mic 2 light on the microphone will stay illuminated.

FLEXMIKE

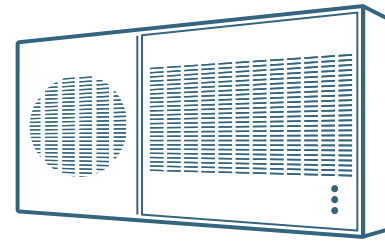
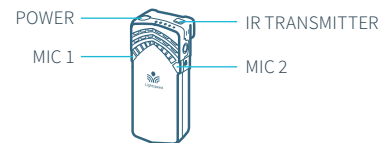
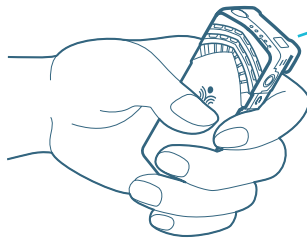

TOPCAT

SHAREMIKE

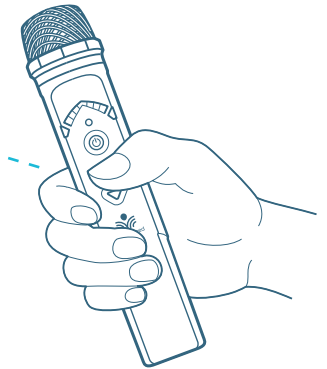

IR TRANSMITTER



BACK

MIC 1
POWER



FRONT

MIC 2



Using the Life Safety Functions

Topcat connects and responds to several important third-party life safety solutions.



1. Alert Notification

INITIATES ALERT WITH FLEXMIKE

If your building is equipped with an alert notification system, simultaneously holding down the volume up and down buttons for three seconds on the Flexmike activates the contact closure function on Topcat. External systems sense this contact closure to perform a prescribed action, notifying the appropriate parties of a classroom alert.



2. Relay Input

MUTES CLASSROOM AUDIO SYSTEM

When Topcat is connected to a fire alarm, audio signals going through the unit are muted when the fire alarm is activated to minimize distractions from the sound of the alarm.



3. PageFirst

MUTES CLASSROOM AUDIO SYSTEM

When the PageFirst sensor clip is connected to an external paging source, all audio signal is muted to ensure paging is heard clearly.

See page 19 for installation details

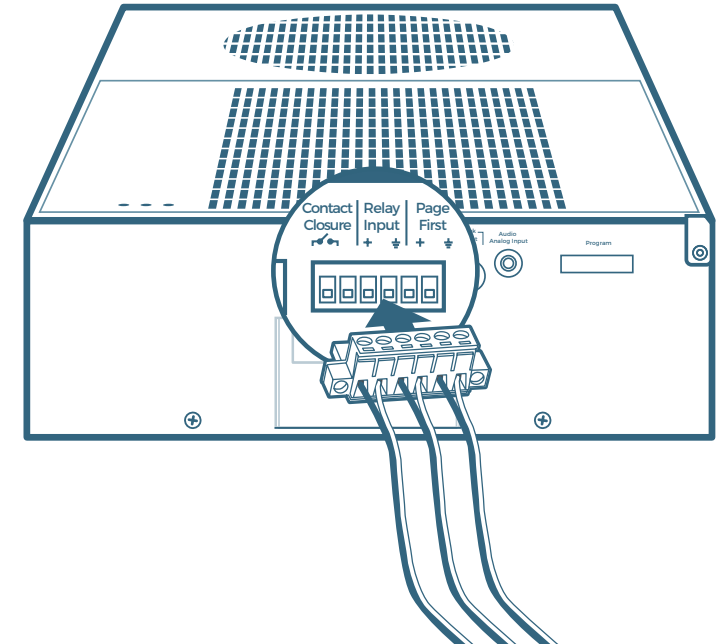
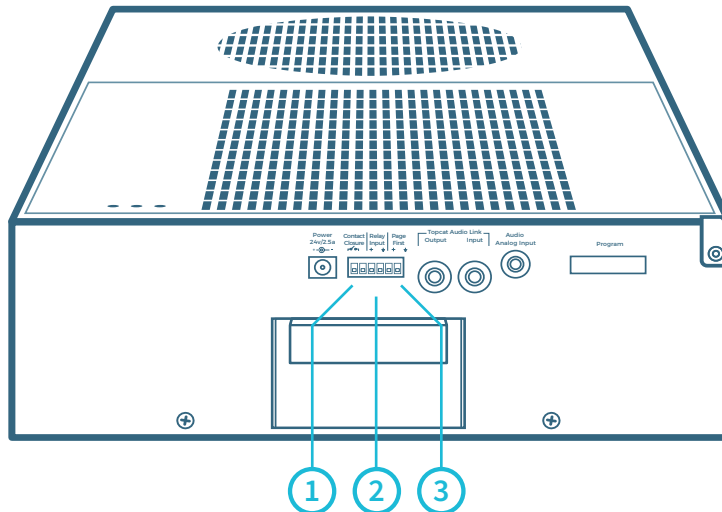



Optional PageFirst Kit

This PageFirst feature for Topcat interfaces with an independent classroom paging system. When the page is broadcast, all audio from the system is muted, ensuring important school-wide messages are never missed. Please note that PageFirst is not compatible with telephone or IP-based paging systems.

HOW IT WORKS

1. PageFirst sensor clip is hung around a lead wire attached to the classroom paging speaker.
2. The clip is hard-wired to the amplifier.
3. As a page is broadcast, the sensor clip detects the audio signal through induction and immediately mutes the amplifier.
4. When the page is over, the audio from the amplifier returns to normal volume level.

For full installation details, refer to the Topcat Installation Guide

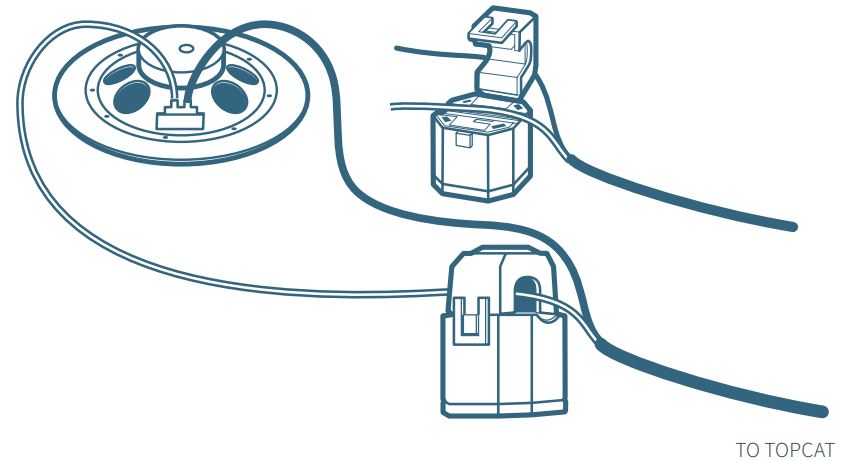

USING ALERT NOTIFICATION

If your building is equipped with an alert notification system, you can use the Flexmike to send an alert. This activates the contact closure function on the Topcat, which external systems use to perform a prescribed action, such as notifying the appropriate parties of a classroom alert.

To send an alert, simultaneously hold down the volume up and volume down buttons on the Flexmike for three seconds.

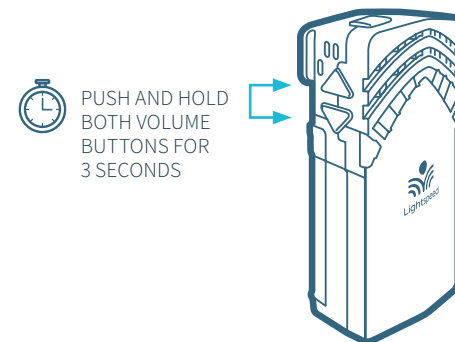



Using Your Microphone as a Wireless Audio Link

You can connect your 2nd (or 3rd) microphone to your computer's USB port to enable a wireless 2-way audio link.

SEND AUDIO FROM THE COMPUTER to the Topcat to ensure all audio from the computer (videos, video conferencing, audio books, music, etc) can be played through Topcat.

SEND AUDIO TO THE COMPUTER from Topcat to ensure the teacher's Flexmike and any student microphones are clearly picked up by a video conferencing solution.

1. With the appropriate USB cable (USB-C for Flexmike/Sharemike) connect your microphone to your computer's USB port. This will also power/charge your microphone.
2. Open sound settings on your computer:
 - Select Lightspeed Audio as the Output source to send all computer audio to Topcat.
 - Select Lightspeed Audio as the Input source to use the Lightspeed microphones as the computer microphone audio for video conferencing and recording applications.
3. You may also need to select Lightspeed Audio as the speaker and microphone audio in your video conferencing application the first time you use it.

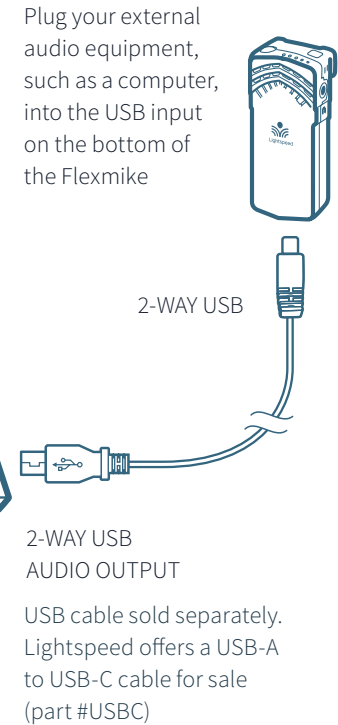
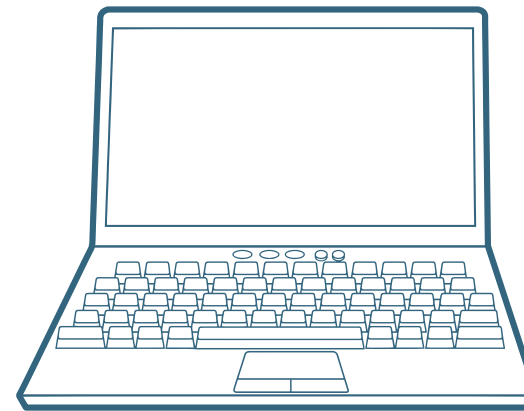

TIP: If your system includes two Flexmikes, you can use one mic for instruction and the second mic to transmit audio through the system.



OPTIONAL ACCESSORIES

ShareMike Controls and Connections

- POWER BUTTON**
- POWER STATUS LIGHT**
Red light: During operation, turns red to indicate low battery
White light: Normal operation

When charging in Cradle Charger:
Red light: Charging
Green light: Charging complete
- MIC 1 STATUS:** Lighted to indicate microphone is registered as Mic 1
White: solid = Normal operation
White: flashing = Linking in process
- MIC 2 STATUS:** Lighted to indicate microphone is registered as Mic 2
White: solid = Normal operation
White: flashing = Linking in process
- MUTE/TALK STATUS LIGHT**
Blue: solid = Talk
White: solid = Mute
- MICROPHONE VOLUME UP/DOWN**
- USB INPUT:** Connect audio source to send to Topcat. USB input can also be used for charging.
- IR TRANSMITTER:** For pairing to base unit
- AUDIO INPUT:** Plug a laptop or other audio device into this jack to wirelessly transmit the audio signal to be played through the system.
- VOLUME LOCK:** Disables volume controls.

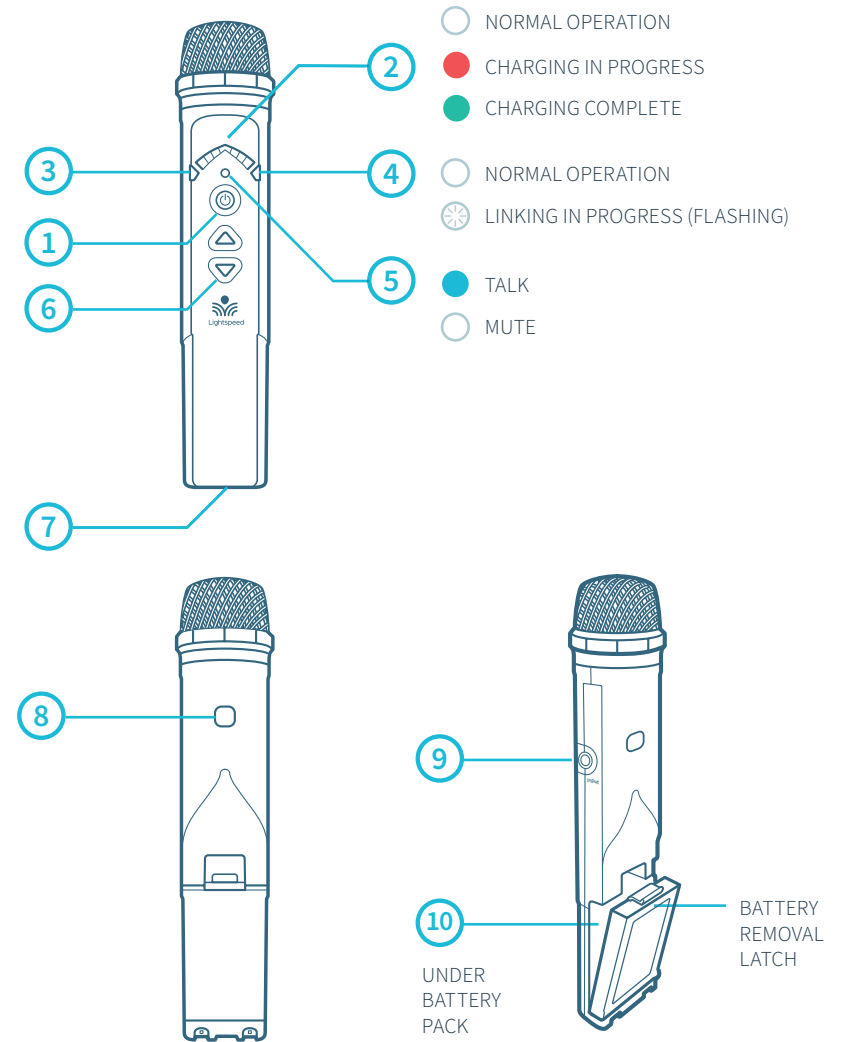



Sharemike: Charging

1. Make sure the charger is plugged into a wall outlet.
2. The power status light on the microphone will glow red to indicate charging.
3. Leave the Sharemike in the charger overnight to obtain a full charge. It takes 5-6 hours to fully charge the battery. The light will turn green when charging is complete.

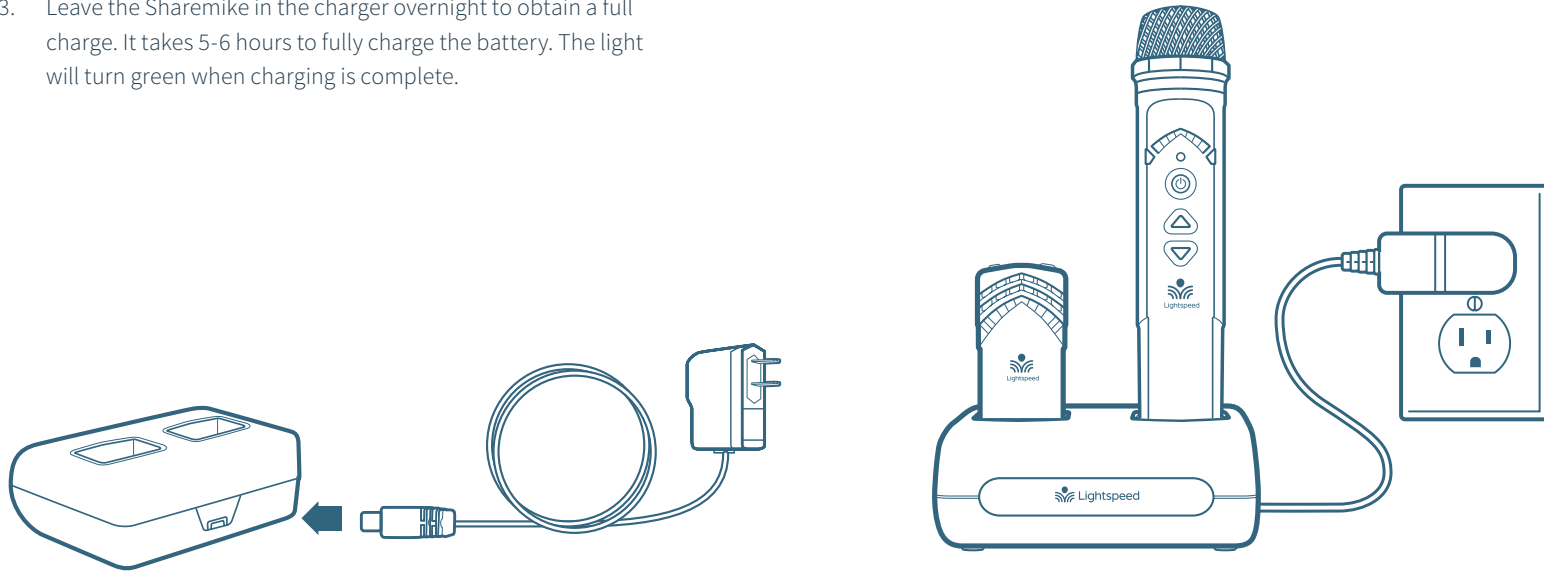

PLEASE NOTE: Topcat and microphone(s) are paired together at the factory and all components should be kept together as a system. Moving them from one system, or room, to another will result in the need to re-pair.



Sharemike: Initial Set-Up

ENSURE TOPCAT IS POWERED ON

The white light on the speaker panel of Topcat will glow.

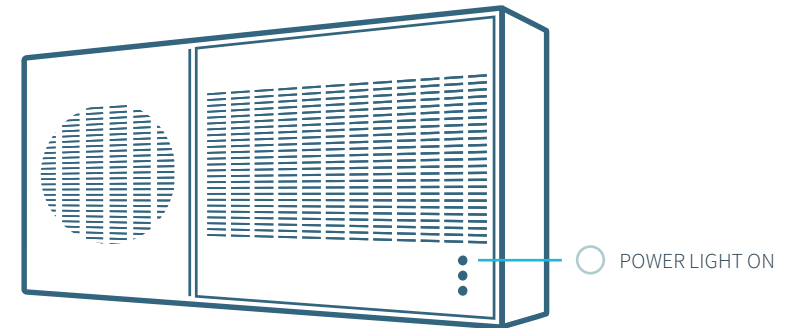

TURN ON THE SHAREMIKE

- Press and hold the power button until the LED lights.
- While speaking in a normal voice, increase the volume using the Activate Volume button or the Media Connector Microphone Volume knob until your voice is barely audible.

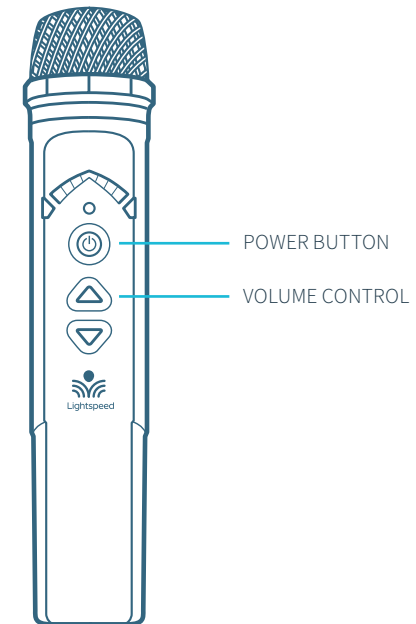

PLEASE NOTE: This equipment is designed to supplement and distribute the user's voice so they are able to speak in a conversational tone. Having the volume set too high will result in feedback and listener fatigue.



Media Connector Set Up and Operation

DETERMINE LOCATION

Media Connector is designed to be connected to the primary media source in the classroom, usually the computer or display panel.

WALL MOUNT OR DESKTOP

The Media Connector can be placed on a table surface or wall-mounted.

- Choose a location that is convenient to the classroom audio sources and power supply.
- It should be located 3-6 feet off of the floor to allow for good transmission.
- Do not enclose in a metal cabinet or in a location where the signal will be obstructed.

NOTE: The Media Connector does not require a direct line of sight to Topcat. However it functions best when no obstructions are between the two devices.



CONNECT TO POWER

Connect the USB power cord to a computer. Plug the USB cable into the USB input on the back of the Media Connector.

or

Use the USB power adapter to plug into a wall outlet.

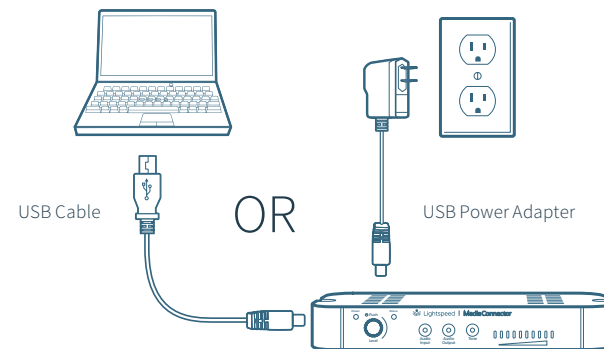



Connecting Media Connector to Audio

Audio can be connected using either a digital 2-way USB audio or analog audio.

USB AUDIO

If locating and connecting to computer USB, Media Connector will default to digital USB audio (3.5mm analog audio ports will be disabled). USB audio enables a 2-way audio link to:

Send audio from the computer to the Media Connector to ensure all audio can be played through the Topcat speaker.

Send audio to the computer from the Media Connector to ensure the teacher's Flexmike and any student microphones are clearly picked up by a video conferencing solution.

DISABLE/ENABLE USB AUDIO

To disable USB Audio and use computer USB for power only

- Unplug USB cable from Media Connector
- Press and hold Audio Output button
- Plug USB cable back to Media Connector
- Status light turns white to indicate USB disabled
- Release Audio Output button and system will reboot with disabled USB-C audio
- Analog Audio Inputs are now active

To enable USB Audio on your Media Connector

- Unplug USB cable from Media Connector
- Press and hold Audio Out button
- Plug USB cable back to Media Connector
- Status light turns blue to indicate USB-C is enabled
- Release Audio Out button and system will reboot with enabled USB-C audio
- Analog Audio Inputs are now inactive

ANALOG AUDIO

Plug your external audio equipment (e.g., video display) into one of the Audio input jacks.

Adjust the volume as needed by pressing the Audio Input selector and adjusting the level knob as needed.

COMPUTER SETTINGS

Once connected, open computer sound setting to select "Lightspeed Audio" as the microphone and speaker.

SETTING THE VOLUME LEVELS

For recording, or to interface with an Assistive Listening Device, connect a 3.5mm cable to the Audio Output of the Media Connector to the microphone input on the device. Press the button for the desired level adjustment.

- Turn the knob to adjust volumes up or down for Audio Input/Output
- To adjust the Tone (bass/treble) of the speaker, press Tone and use the adjustment knob to turn the bass up and down

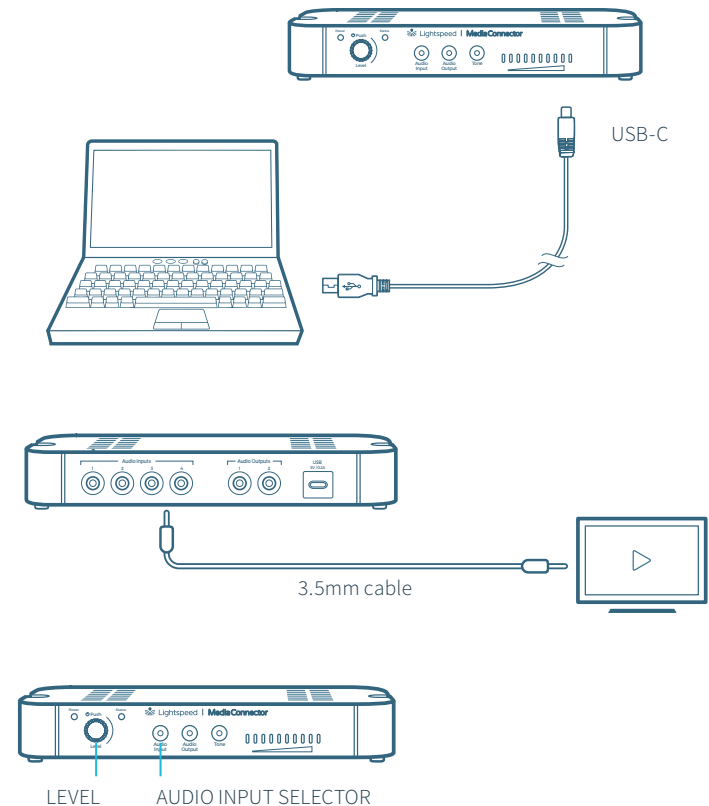



Pairing Topcat to Media Connector (Optional)



Your system is shipped with microphones and base units pre-paired for quick and easy use.

If for any reason you need to pair new components, follow this pairing process:

PLEASE NOTE: Microphones should be out of the charger while pairing.

①

With the microphone turned on, point the IR transmitter lens toward the Topcat (for ShareMike, the transmitter lens is located on the back of the microphone).

②

Press and hold the Flexmike power button for 5 seconds until the status light on the Topcat starts flashing, then release the button. At this point, the status light on Topcat will blink for 30 seconds.

If after 30 seconds the status light blinks rapidly, you will need to start the pairing process again.

③

With the Media Connector powered on, press and hold the tone button to put it into pairing mode.

When the status lights are solid on both Topcat and Media Connector, pairing is successful.

TOPCAT

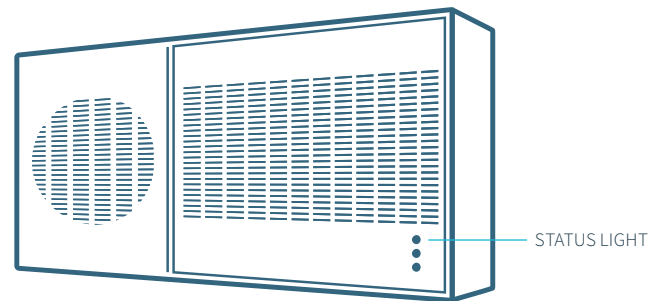

FLEXMIKE

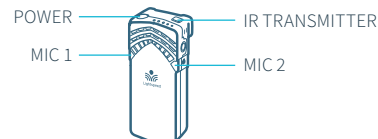

MEDIA CONNECTOR

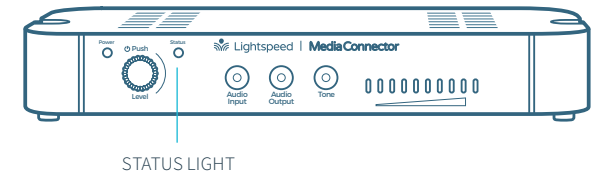



Media Connector: Audio Integration

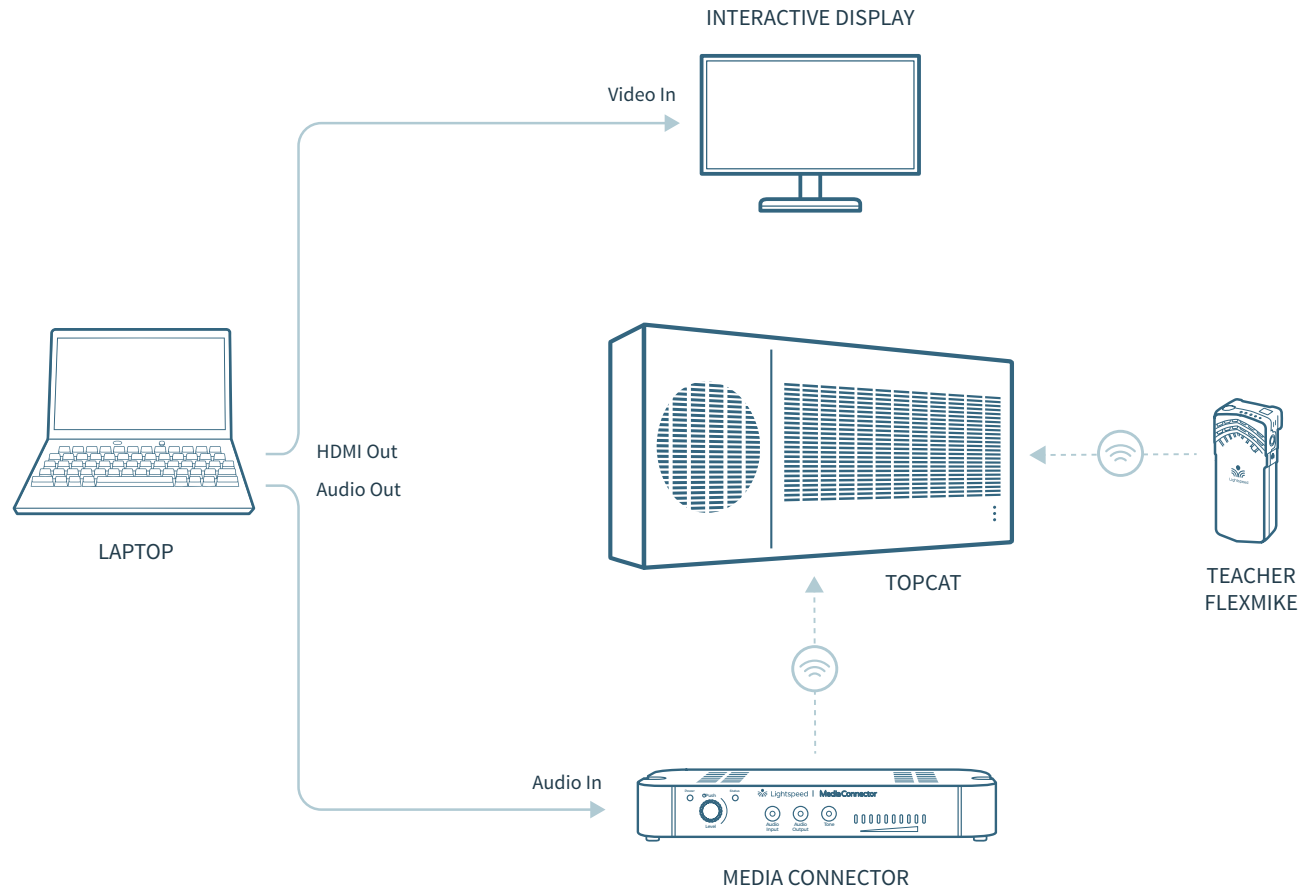



Activate System with Pods

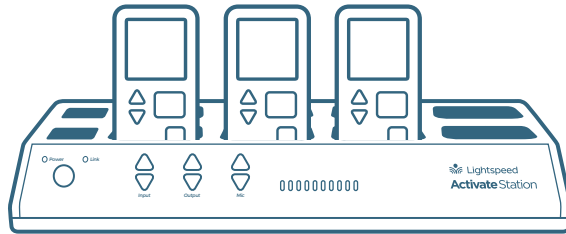

For Small Group Instruction

Activate with Pods is a two-way communication system that can be seamlessly added to the Topcat system to facilitate small group instruction.

With the small group audio pods and the Activate app, Activate opens up communication and interaction between the teacher and student groups, including:

- Teacher monitoring of individual small groups
- Direct instruction to each independent group
- Student group sharing with the whole class
- Reinforce and redirect group activities
- Capture audio and video of student groups or of individual speaker

If your Topcat system was configured with Activate pods, please refer to the Activate System user guide for operation and setup instructions.

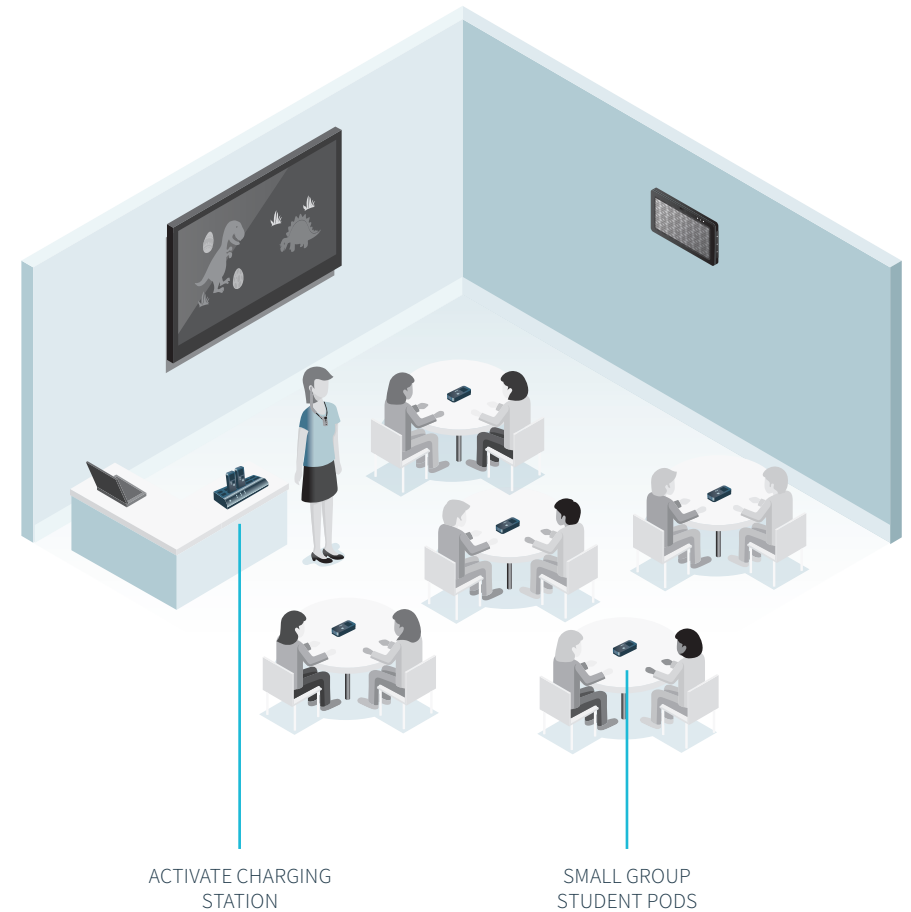



MAINTENANCE & TROUBLESHOOTING

Flexmike Battery Replacement

Battery part # L3.7V

1. Push down on the latch and carefully pull the battery pack away from the Flexmike.
2. Insert new battery pack as shown and make sure the latch is secure.
3. Place the Flexmike in a cradle charger to charge the battery pack.

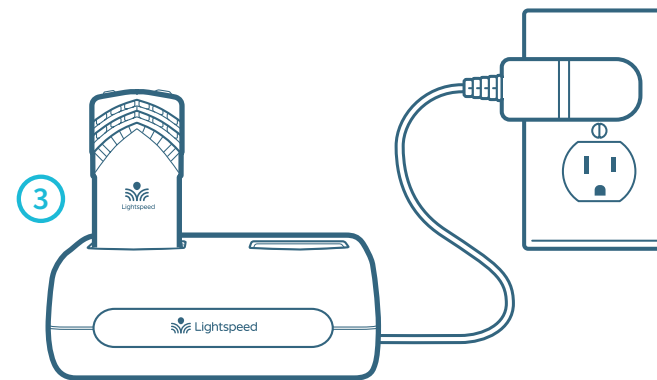
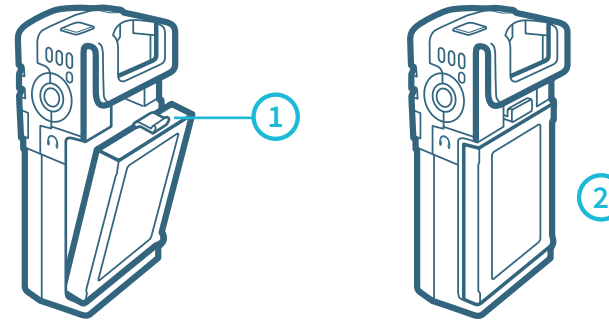



ShareMike Battery Replacement

Battery part # L3.7V

1. Push down on the latch and carefully pull the battery pack away from the ShareMike.
2. Insert new battery pack as shown and make sure the latch is secure.
3. Place the Flexmike in a cradle charger to charge the battery pack.

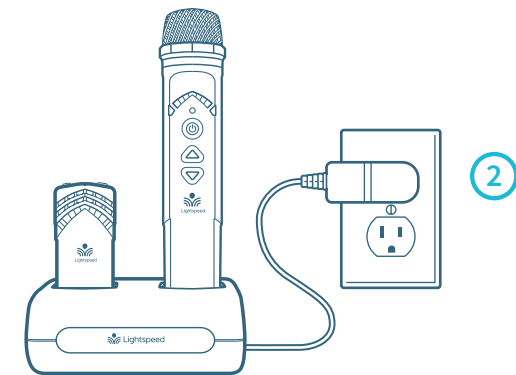
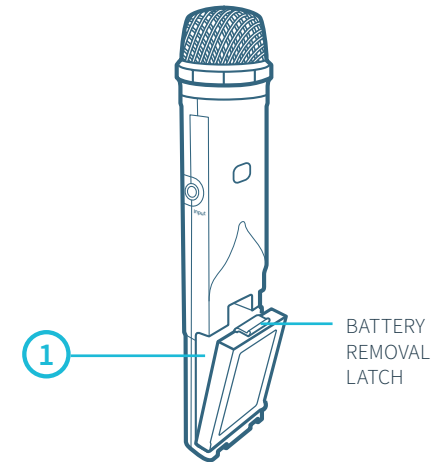



Troubleshooting

PROBLEM: Low battery indication: Most problems are directly related to low battery power. Please run through the “Battery Check” items first. For remaining troubleshooting, use known good, fully-charged batteries.

SOLUTION: Battery Check

- Confirm batteries are charged each night. A solid red light on the battery status light indicates a low battery.
- Confirm proper batteries are used: Flexmike and Sharemike require the Lightspeed L3.7V rechargeable battery pack.
- Make sure the microphones obtain a full charge. A full charge takes 5-6 hours.
- When charging the transmitter, the red charging light is solid. The green light will be solid when a full charge is reached.

PROBLEM: Microphone doesn’t indicate a “Ready” signal (solid white light)

SOLUTION: Follow these steps to ensure the system is ready to use.

- Ensure the power button on the microphone is turned on. Once turned on, the blue light should begin blinking.
- Power the microphone off, then on again after a few seconds. Wait for up to 30 seconds for the white light to turn solid, indicating READY for operation.

PROBLEM: Low volume or feedback

SOLUTION: Follow these steps to eliminate low volume or feedback:

- If the volume is too high, feedback will occur. Adjust accordingly.
- Adjust the volume level on the Flexmike.

PROBLEM: No sound from speaker and wireless components

SOLUTION: Follow these steps to produce sound from Topcat:

- Confirm that the white POWER light located on the front panel of the Topcat is on.
- Confirm the microphone is powered on and linked to Topcat. The Mic 1 status light will be blue on Topcat indicating the microphone is linked.
- Confirm that the microphone is turned on. There will be a solid blue light on the top of microphone to indicate it is powered on and ready.
- Confirm that microphone is not muted. A solid white light on the top of microphone will indicate it is muted.
- Check speaker connections on Topcat. Make sure the cables are properly connected (see page 9 of this manual or the Installation Guide for more information).
- If an Activate Station or Media Connector is paired with Topcat, make sure that the volume level of the Activate or the Media Connector is not turned down all the way.
- Slowly turn up the volume level while talking into the microphone.

PROBLEM: Software update is needed

SOLUTION: Go to <https://app.tara.lightspeed-tek.com/> and follow the steps.

- For a step by step video tutorial please visit <https://www.youtube.com/watch?v=dGnhziACJ9c>

If you still have questions after reviewing these instructions, call Lightspeed Technical Services at 800.732.8999, 5am–5pm, PST.

Customers outside the U.S. should contact their local reseller.



WARRANTY, SAFETY & SPECIFICATIONS

Five-Year Limited Warranty

Lightspeed Classroom Audio Systems are guaranteed against malfunction due to defects in materials and workmanship for a period of five (5) years, beginning at the date of the purchase invoice. If such malfunction occurs, the product will be repaired or replaced (at Lightspeed's option) without charge during the warranty period.

Lightspeed's Warranty Exchange Program applies to all classroom audio systems within the five (5) year warranty period. If a classroom audio product or component has an issue that requires service, a refurbished replacement will immediately be sent to the customer to minimize downtime. Customers will receive the exchange product(s) or component(s) within 2-3 days. A prepaid return label will be included with exchanged products so original malfunctioned equipment can be returned to Lightspeed. Any exchanged equipment will remain covered under the original five-year warranty.

1. Warranty on transceivers is five (5) years.
2. Warranty on Lightspeed NiMH and Lithium Polymer rechargeable batteries is one (1) year.
3. Warranty on microphones and components that support discontinued systems (FMA, SMA and FMCA) is one (1) year.
4. A prepaid shipping label will be provided by Lightspeed for warranty repairs within the United States. Customers outside the U.S. should refer to the Lightspeed website (www.lightspeed-tek.com) for warranty repair instructions.
5. Warranty does not extend to finish, appearance items, or malfunctions due to abuse or operation other than specified conditions, nor does it extend to incidental or consequential damages. Repair by other than Lightspeed or its authorized service agencies will void this warranty. Information on authorized service agencies is available from Lightspeed Technologies, Inc.

Our Service Department (800.732.8999, 5am–5pm, PST) will handle your repair or replacement needs.

Customers outside the U.S. should contact their local reseller.



Safety Warnings and Certifications



CAUTION

RISK OF ELECTRICAL SHOCK

DO NOT OPEN



THIS PRODUCT MUST BE INSTALLED IN ACCORDANCE WITH THE APPLICABLE INSTALLATION CODE BY A PERSON FAMILIAR WITH THE CONSTRUCTION AND OPERATION OF THE PRODUCT AND THE HAZARDS INVOLVED.



The lightning flash with arrowhead symbol inside an equilateral triangle is intended to alert the user to the presence of non insulated “hazardous voltage” within the product’s enclosure, which may be of sufficient magnitude to induce a risk of electric shock to persons.



The exclamation mark inside an equilateral triangle is intended to alert the user to the presence of important operating and maintenance (servicing) instruction in the literature accompanying this product.



USE A LIGHTSPEED SUPPLIED BATTERY ONLY



CAUTION: Risk of explosion if battery is replaced by an incorrect type. Dispose of used batteries according to the instructions.



Battery subjected to extremely low air pressure that may result in an explosion or the leakage of flammable liquid or gas.

CERTIFICATIONS



This product is listed to UL standards and requirements for electrical safety by Underwriters Laboratories Inc.



This product conforms with the essential requirements of the following European Union Directives: 2004/108/EC Electromagnetic Compatibility (EMC) and 2006/95/EC Low Voltage Directive (LVD).



LightSpeed Technologies launched a formal product recycle program in Europe that complies with the European Union Directive 2002/96/EC on Waste Electrical and Electronic Equipment (“WEEE Directive”). Please visit www.light-speed-tek.com for more information.



This product is manufactured using lead-free processes and is free of other materials harmful to the environment. It conforms to the most stringent new European guidelines for consumer products (RoHS).



Précautions De Sécurité et Certifications



ATTENTION
RISQUE D'ÉLECTROCUTION
NE PAS OUVRIR



CONFORMÉMENT AUX NORMES D'INSTALLATION APPLICABLES, CE PRODUIT DOIT ÊTRE INSTALLÉ PAR UNE PERSONNE FAMILIARISÉE AVEC LA CONCEPTION ET LE FONCTIONNEMENT DU PRODUIT ET CONSCIENTE DES RISQUE ENCOURUS.



L'éclair flèche dans un triangle équilatéral avertit l'utilisateur de la présence d'une "tension dangereuse" non isolée à l'intérieur de l'appareil, qui peut être d'une ampleur suffisante pour constituer un risque d'électrocution.



Le point d'exclamation contenu dans un triangle équilatéral avertit l'utilisateur de la présence d'importantes instructions d'exploitation et de maintenance dans la documentation qui accompagne ce produit.



UTILISEZ UNIQUEMENT LA BATTERIE LIGHTSPEED FOURNIE



ATTENTION: Risque d'explosion si la batterie est remplacée par un type incorrect. Mettre au rebut les batteries usagées selon les instructions.

CERTIFICATIONS



Ce produit est certifié conforme aux normes et aux exigences UL en matière de sécurité électrique par Underwriters Laboratories Inc.



Ce produit est conforme aux principales exigences des directives de l'Union Européenne suivantes : 2004/108/EC Electromagnetic Compatibility (EMC) and 2006/95/EC Low Voltage Directive (LVD).



Lightspeed Technologies a lancé un programme de recyclage de produits en Europe conformément à la directive de l'Union Européenne 2002/96/CE relative aux déchets d'équipements électriques et électroniques (directive « DEEE »). Veuillez visiter notre page Web www.Lightspeed-tek.com pour plus de renseignements.



Ce produit est fabriqué en utilisant des processus sans plomb ni aucune autre matière nuisible à l'environnement. Il est conforme aux nouvelles règles européennes les plus strictes en matière de biens de consommation (RoHS).



Canada, Industry Canada (IC) Notices

English

This device complies with Industry Canada license exempt RSS standard(s). This Class B digital apparatus complies with Canadian ICES-003 and CAN ICES-3(B)/NMB-3(B). Operation is subject to the following two conditions: (1) this device may not cause interference, and (2) this device must accept any interference, including interference that may cause undesired operation of the device. The IC for this device is IC ID 1732B-LSTCN. This includes accessories such as the Flexmike (IC 1732B-LSFMN), Sharemike (IC 1732B-LSSMN) and Media Connector (IC 1732B-LSMCN).

French

Canada, avis d'Industrie Canada (IC)

Cet appareil numérique de classe B est conforme aux normes canadiennes ICES-003 et RSS-247. Son fonctionnement est soumis aux deux conditions suivantes: (1) cet appareil ne doit pas causer d'interférence et (2) cet appareil doit accepter toute interférence, notamment les interférences qui peuvent affecter son fonctionnement. L'identifiant IC de cet appareil est IC ID 1732B-LSTCN. Ceci inclus les accessoires comme le Flexmike (IC 1732B-LSFMN), Sharemike (IC 1732B-LSSMN) et un Media Connector (IC 1732B-LSMCN).

Cet équipement est conforme aux limites d'exposition aux radiations IC inaux doivent suivre les instructions d'utilisation spécifiques pour satisfaire la conformité à l'exposition IC, veuillez suivre les instructions de fonctionnement décrites dans ce manuel.



FCC Notice to User

This device complies with Part 15 of the FCC Rules. Operation is subject to the following two conditions:

1. This device may not cause harmful interference; and
2. This device must accept any interference received, including interference that may cause undesired operation.

This equipment has been tested and found to comply with the limits for a Class B digital device, pursuant to Part 15 of the FCC Rules. These limits are designed to provide reasonable protection against harmful interference in a residential installation.

This equipment generates, uses, and can radiate radio frequency energy and, if not installed and used in accordance with the instructions, may cause harmful interference to radio communications. However, there is no guarantee that interference will not occur in a particular installation.

If this equipment does cause harmful interference to radio or television reception, which can be determined by turning the equipment off and on, the user is encouraged to try to correct the interference by one or more of the following measures:

- Reorient or relocate the receiving antenna (that is, the antenna for radio or television that is receiving the interference).
- Reorient or relocate and increase the separation between the telecommunications equipment and receiving antenna.
- Connect the telecommunications equipment into an outlet on a circuit different from that to which the receiving antenna is connected.
- Consult the dealer or an experienced radio/TV technician for help.

English

IMPORTANT NOTE: To comply with the FCC RF exposure compliance requirements, the antenna(s) used for this transmitter must be installed to provide a separation distance of at least 20 cm from all persons and must not be co-located or operating in conjunction with any other antenna or transmitter. No change to the antenna or the device is permitted. Any change to the antenna or the device could result in the device exceeding the RF exposure requirements and void user's authority to operate the device.

French

NOTE IMPORTANTE: Pour se conformer aux règles d'exposition des ondes RF par la FCC, la (ou les) antenne(s) utilisée(s) par ce transmetteur doivent être installées de façon à être séparée d'une distance d'au moins 20 cm de toute personne et ne doit pas être utilisée près ou en conjonction avec aucune autre antenne ou transmetteur. Aucune modification à l'antenne ou à l'appareil n'est permise. Toute modification à l'antenne ou à l'appareil peut résulter que l'appareil excèdera l'exposition aux ondes RF réglementaires et ainsi annuler le droit à l'utilisateur d'utiliser l'appareil.

FCC RF Radiation Exposure Statement

This device (Access Link) complies with the FCC RF radiation exposure limits set forth for an uncontrolled environment. This device should be installed and operated with a minimum distance of 20cm between the radiator (Access Link) and any part of your body.

For body worn operation, the portable part (Flexmike) has been tested and meets FCC RF exposure guidelines.

This device must not be co-located or operating in conjunction with any other antenna or transmitter. The changes or modifications not expressly approved by the party responsible for compliance could void the user's authority to operate the equipment.

Notice to Canada User

English

This device complies with Industry Canada license exempt RSS standard(s).

Operation is subject to the following two conditions:

1. This device may not cause interference, and
2. This device must accept any interference, including interference that may cause undesired operation of the device.

French

Le présent appareil est conforme aux CNR d'Industrie Canada applicables aux appareils radio exempts de licence.

1. L'exploitation est autorisée aux deux conditions suivantes :
2. L'appareil ne doit pas produire de brouillage, et l'utilisateur de l'appareil doit accepter tout brouillage radioélectrique subi, même si le brouillage est susceptible d'en compromettre le fonctionnement.



RF Radiation Exposure Statement

English

Your mobile device is a radio transmitter and receiver. It is designed not to exceed the limits for exposure to radio waves (radio frequency electromagnetic fields) recommended by international guidelines. The guidelines were developed by Health Canada and include a substantial safety margin designed to assure the safety of all persons, regardless of age and health.

French

Votre appareil mobile est un émetteur-récepteur radio. Il est conçu pour ne pas dépasser les limites d'exposition aux ondes radio (champs électromagnétiques de fréquence radio) recommandées par les directives internationales. Les lignes directrices ont été élaborées par Santé Canada et comprennent une marge de sécurité importante destinée à assurer la sécurité de toutes les personnes, indépendamment de l'âge et de la santé.

NOTICE FOR USB

NOTE: Lightspeed is not responsible for any changes or modifications not expressly approved by the party responsible for compliance. Such modifications could void the user's authority to operate the equipment.

NOTE: This equipment has been tested and found to comply with the limits for a Class B digital device, pursuant to part 15 of the FCC Rules. These limits are designed to provide reasonable protection against harmful interference in a residential installation. This equipment generates, uses and can radiate radio frequency energy and, if not installed and used in accordance with the instructions, may cause harmful interference to radio communications. However, there is no guarantee that interference will not occur in a particular installation. If this equipment does cause harmful interference to radio or television reception, which can be determined by turning the equipment off and on, the user is encouraged to try to correct the interference by one or more of the following measures:

- Reorient or relocate the receiving antenna.
- Increase the separation between the equipment and receiver.
- Connect the equipment into an outlet on a circuit different from that to which the receiver is connected.
- Consult the dealer or an experienced radio/TV technician for help.



EU Declaration of Conformity

According to EU Directives EMC 2014/30/EU, LVD 2014/35/EU, RED 2014/53/EU, RoHS 2011/65/EU

Manufacturer: Lightspeed Technologies, Inc.
Address: 11509 SW Herman Rd.
Tualatin, Oregon 97062

We herewith declare that the following systems comply with the appropriate basic safety and health requirements of the Directive based on its design and type, as brought into circulation by us. In case of alteration of the system, not agreed upon by us, this declaration will lose its validity.

Products: Redcat, Topcat, 975, Access Link, Flexmike, Sharemike, Pod, Activate Station, Media Connector, Mobile PA

Model Numbers: RCN, TCN, 975, ALN, FMN, SMN, POD, ACT, MCN, MPA

As applicable, products conform to the standards listed below:

EN 62368-1:2014
IEC 62133:2012
EN 50385:2017
EN 50566:2017
EN 50663:2017
EN 62479:2010
ETSI EN 301 406 V2.2.2 (2016-09)
ETSI EN 301 489-1 V2.2.3 (2019-11)
ETSI EN 301 489-6 V2.2.1 (2019-04)
EN IEC 63000:2018

The Technical Construction File is available to proper authorities and the product is CE marked.

Lightspeed Representative

Date: December 6, 2022

Michael Frost, Compliance Engineer



System Components

STANDARD COMPONENTS

TCNG	Topcat all-in-one ceiling-mount wireless audio base station
24V2.5	24V/2.5A power supply for TCN
FSC	Transceiver cradle charger, power supply
USBC	USB-C charging cable
USB1	USB-AC charging/power adapter
FMNG	Flexmike classroom transceiver with battery pack and lanyard
NH2.4V	AA NiMH rechargeable battery pack for Flexmike
FL	Flexmike lavalier cord

STANDARD COMPONENTS (outside U.S. and Canada)

TCN	Topcat all-in-one ceiling-mount wireless audio base station
24V2.5	24V/2.5A power supply, specific country
FSC	Transceiver cradle charger, power supply
USBC	USB-C charging cable
USB1	USB-AC charging/power adapter
FMN	Flexmike classroom transceiver with battery pack and lanyard
NH2.4V	AA NiMH rechargeable battery pack for Flexmike
FL	Flexmike lavalier cord

OPTIONAL ACCESSORIES

INS-F6	Activate for small group instruction
INS	Activate charging station with Bluetooth
24V1.75	24V/1.75A power supply for ACT
SMN	Sharemike handheld transceiver with battery pack
NH2PK	AA NiMH rechargeable battery pack for Sharemike
UDC	Charging cable for Sharemike
MCN	Wireless audio transceiver
USB1	MCA power supply
UMCB	USB Type A-Micro B power cable for MCA
DC50	50' plenum rated DC power cable kit
EMA	Earset microphone with TRRS connector for Flexmike
LMA	Lapel microphone with TRRS connector for Flexmike



System Specifications

TOPCAT

Description	All-in-one ceiling-mount wireless base station
Panel size	16.25" x 8.25"
Frequency response	60 Hz - 18 kHz (-10dB)
Wireless communication	Access Technology (1.9 GHz + RF4CE)
Tone control	1 bass/treble control, inside cabinet
Audio input	One (1) 3.5mm stereo w/ volume control inside cabinet
Power output	20W RMS x 2
Power input	AC: 100-240V ~ 50 / 60Hz 1.5A DC:24V / 2.5A
PageFirst input	2-pin Euroblock with sensitivity adjust
Audio Link indicators	2 indicators for Flexmike 1 and 2
Device registration	Push button for pod(s), Flexmike(s), Sharemike, Activate, and Media Connector
Dimensions (W x H x D)	24" x 12" x 3.7" (595 x 295 x 94mm)
Weight	13.6 oz. (6.2 kg)

FLEXMIKE (1-2)

Description	Pendant-style transceiver
Earbud lanyard	Magnetic clasp with integrated earbud
Wireless communication	Access Technology (1.9 GHz)
Audio distortion	<1%
Integrated microphone	Uni-directional electret
Earbud output	3.5mm
Audio input	USB-C
Volume control	+/- 6 dB
Battery power	3.7V LiPo battery pack
Battery life	8 hours (fully charged)
Charging	2 contacts for cradle charging
USB connection	Type C for charging and audio
Power	On/off switch

Registration	Push button for registration with Access Link
Dimensions (L x W x H)	2.9" x 1.1" x 0.7" (74 x 28 x 18mm)
Weight	1.2 oz (34g)

SHAREMIKE

Description	Handheld transceiver
Wireless communication	Access Technology (1.9 GHz)
Audio distortion	<1%
Integrated microphone	Uni-directional electret
Audio input	3.5mm
Battery power	3.7V LiPo battery pack
Battery life	8 hours (fully charged)
Charging	2 contacts for cradle charging
Power	On/off button
Registration	Push button for registration with Access Link
Dimensions (L x W x H)	6.0" x 1.1" x 1.1" (153 x 28 x 28mm)
Weight	2.6 oz (73g)

MEDIA CONNECTOR

Description	Wireless audio transceiver
USB power	5V USB-C connector
Wireless communication	Access Technology (1.9 GHz)
Tone control	1 bass/treble control
Audio input	3.5mm stereo (x4) with master volume
Audio output	3.5mm stereo (X2) mixed with volume control
Audio Link indicator	1 LED on front panel
Device registration	Push button for Access Link
Dimensions (W x H x D)	7.6" x 5" x 1.13" (193 x 127 x 29mm)
Weight	9.6 oz. (272g)



Dedicated to Access for All

We strive to make a remarkable difference for teachers and students by creating Access to powerful in-the-moment insights to the learning process. Our audio and video solutions improve student engagement, enable teachers to activate small groups, and encourage collaboration.

11509 SW Herman Road
Tualatin, Oregon 97062
Toll Free: 800.732.8999
Phone: 503.684.5538
Fax: 503.684.3197
lightspeed-tek.com